

# MiniPro Video PTZ Camera User Manual (V2.2)

## 1 Camera Interface

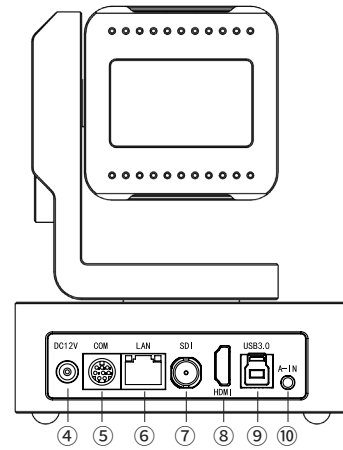
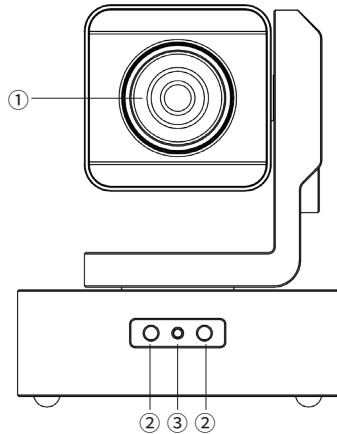

No.	Explain	No.	Explain	No.	Explain
1	Lens	4	DC12V Input	7	3G-SDI
2	IR Receiver	5	COM(RS485/RS232)	8	HDMI
3	Power Indicated Light	6	RJ45/ IP Streaming/ POE	9	USB 3.0
				10	Audio Interface

## 2 Packing Box

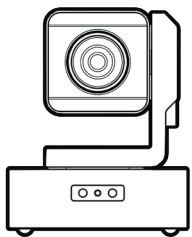

PTZ Camera × 1



IR Remote Controller × 1

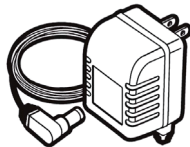

Power Adapter × 1

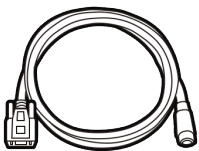

RS232 to DB 9Pin  
Cable × 1

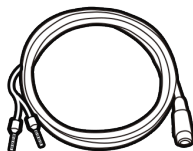

RS485 to 2Pin  
Cable × 1

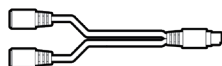

COM Cable × 1



USB3.0 Cable × 1

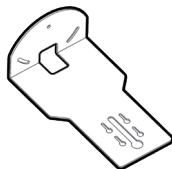

Ceiling Bracket / Wall  
Support × 1

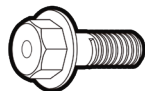

Retaining Screw × 8



Warranty Card × 1

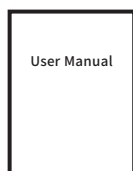

User Manual × 1



Certificate × 1

## 3 Specification

### Camera

Zoom	10X Optical	20X Optical	30X Optical
Image Sensor	1/2.7" Exmor CMOS Sensor	1/2.8" Exmor CMOS Sensor	1/2.8" Exmor CMOS Sensor
Effect Pixel	2.38 Megapixel	3.27 Megapixel	3.75 Megapixel
Lens	f=5.1mm - 51mm F=1.6(W) - 3.5(T)	f=4.7mm - 94mm F=1.6(W) - 3.5(T)	f=5.2mm - 148.4mm F=1.3(W) - 4.8(T)
HOV	72°	60.2°	65°
Min Illumination	0.5lux / 0.095lux		
Shutter	1 to 1/10000s		
Digital Noise Reduce	2D & 3D		
Image Mirror/Flip	Support		

### General Parameter

HD Video Output			
3G-SDI × 1, HDMI × 1, IP Streaming × 1, USB3.0 × 1			
Audio Input			
1-ch 3.5mm Audio Interface			
Communications		Power Connector Type	
RS232 IN/OUT, RJ45, RS485		DC 12V JEITA Standard or POE (Power Over Ethernet)	
Operation		Environmental	
Pan Rotation	-178° ~ +178°	Dimensions (L*W*H)	120mm × 120mm × 145mm
Tilt Rotation	-30° ~ +90°	Operating Temperature	-10°C ~ 50°C
Max Presets	Remote Max 9 Presets	Gross Weight	1.4 kg
	PTZ Controller Max 255 Presets	Installation Method	Wall Mount/ Ceiling/ Tripod

## 4 Remote Controller Specification

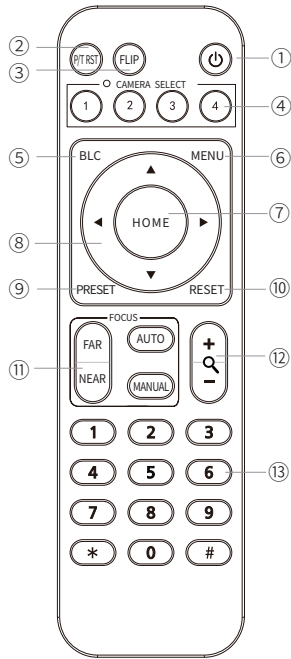

No.	Key	Function
1	Power Key	After pressing, the camera enters standby mode
2	P/T RST Key	After pressing, the camera enters self-check
3	Flip Key	Set the camera image to flip
4	Camera Select Key	Select the camera to be controlled
5	BLC Key	Turn on/off BLC
6	Menu Key	Enter/Exist Menu
7	HOME Key	Press HOME button, the camera returns to the middle position
8	Camera PTZ Control Key	Press the corresponding buttons to adjust the angle of the lens
9	Preset Setting Key	Press "Preset"+Number(1-9) to save the corresponding Preset
10	Preset Reset Key	Press "Reset"+Number(1-9) to reset the corresponding Preset
11	Focus Key	[AUTO]: Automatic focus [MANUAL]: Manual focus [FAR]: Manual focus, make the far object clearer [NEAR]: Manual focus, make the near object clearer
12	Zoom Key	+ Increase, - Decrease
13	Number Key	Cooperate with setting / calling Preset

## 5 Video Format

Video Format	
1	1080P@60/59.94/50/30/29.97/25
2	1080i@60/59.94/50/30/25
3	720P@60/59.94/50/30/25

## 6 Precaution

### Electrical Safety

Confirm country and local electrical safety standard when using or installing the product. The product itself has no power switch, Please stop power supply or plug out power socket when it is not in good working. Video wire and control wire should be insulated and individual connected, can't mix-up with other wires.

### Transportation with Care

Product should be protected against extremes of stress, vibration and moisture in transport, storage and installation. It is transported by integrated packing style.

### Power Supply

Product supplies 12V DC power, or power over Ethernet.

### Installation with Care

Don't turn camera head manually. Doing so may result in mechanical damage.

Product should be put on stable horizontal table, and does not be installed at a tilt, or else, which may cause tilted image.

Don't focus the camera directly to the sun or other bright objects no matter when in use or not. Otherwise, it may affect image quality.

Don't apply corrosive liquid, gas or solid, to avoid damaging the cover which is made up of plastic material.

Make sure there is no obstacle with the camera's rotational range when installing.

Never power on before installation has been completed.

### Prohibited Unauthorized Disassemble

There is no part for users to disassemble voluntarily. The Company is not responsible for any unauthorized modification or dismantling.

## 7 FAQ Processed

### Image Aspect

#### ● No image displayed

- 1) To check the USB3.0 Cable whether already connection with your device correct, and the Power Indication Light whether is Green.
- 2) To check the Video Format whether meet your TV/Monitor or Display.
- 3) To check whether the USB Port and USB Cable of Terminal device are connected Correctly Or whether this device is recognized.

#### ● The image breaks frequently

To check whether the USB port and USB cable of the terminal device are connected correctly.

#### ● The definition is not good after accessing software

To check the software video input settings to see if the camera video input is set to 1920 \* 1080.

### Control Aspect

#### ● Remote controller doesn't work

- 1) To check and replace the batteries.
- 2) To check if the camera working mode is correctly.

## 8 RoHS Declaration

Component	The Hazardous Substances or Elementary Name					
	Pb	Hg	Cd	CrVI	PBB	PBDE
Metal	×	○	○	○	○	○
Plastic	○	○	○	○	○	○
Glass	×	○	○	○	○	○
Circuit Board	×	○	○	○	○	○
Mains	×	○	○	○	○	○
Accessory	×	○	○	○	○	○

○ : means all the contained hazardous substance are within the limitation of SJ/T11363-2006 standard.

× : means all the contained hazardous substance are within the limitation of SJ/T11363-2006 standard.